

NBC- 5,0-93B/M12FSD - Network cable



1407530

<https://www.phoenixcontact.com/us/products/1407530>

Please be informed that the data shown in this PDF document is generated from our online catalog. Please find the complete data in the user documentation. Our general terms of use for downloads are valid.



Network cable, PROFINET CAT5 (100 Mbps), EtherCAT[®] CAT5 (100 Mbps), 4-position, shielded (Advanced Shielding Technology), free cable end, on Socket straight M12, coding: D / IP67, cable length: 5 m

Commercial data

Item number	1407530
Packing unit	1 pc
Minimum order quantity	1 pc
Sales key	BF04
Product key	BF1CJN
Catalog page	Page 198 (C-6-2019)
GTIN	4046356778350
Weight per piece (including packing)	345 g
Weight per piece (excluding packing)	344 g
Customs tariff number	85444210
Country of origin	PL

Technical data

Notes

General	This product corresponds to the PROFINET Cabling and Interconnection Technology Guideline for PROFINET regulations, version 2.00, order no: 2.252, Chapter 10.1 Cord Sets for Balanced Cabling
General	Further products with variable cable type and variable cable length can be found in the accessories section

Product properties

Product type	Data cable preassembled
Sensor type	PROFINET
Number of positions	4
Application	Standard
No. of cable outlets	1
Shielded	yes
Coding	D

Insulation characteristics

Overvoltage category	II
Degree of pollution	3

Interfaces

Bus system	PROFINET
Signal type/category	PROFINET CAT5 (IEC 11801), 100 Mbps EtherCAT [®] CAT5 (IEC 11801), 100 Mbps

Signaling

Status display	No
Status display present	No

Electrical properties

Nominal voltage U_N	48 V AC
	60 V DC
Nominal current I_N	4 A
Transmission medium	Copper
Transmission characteristics (category)	CAT5 (IEC 11801:2002)

Material specifications

Flammability rating according to UL 94	V0
--	----

Connector

Connection 1

Type	free cable end
------	----------------

NBC- 5,0-93B/M12FSD - Network cable



1407530

<https://www.phoenixcontact.com/us/products/1407530>

Connection 2

Type	Socket straight M12 / IP67
Number of positions	4
Coding type	D (Data)
Handle color	black
Material	CuSn (Contact) Ni/Au (Contact surface) PA (Contact carriers) TPU, hardly inflammable, self-extinguishing (Grip) Zinc die-cast, nickel-plated (Screw connection) FKM (Seal)
Insertion/withdrawal cycles	≥ 100
Contact resistance	≤ 5 mΩ
Insulation resistance	≥ 100 MΩ
Tightening torque	0.4 Nm
Degree of protection	IP67
Ambient temperature (operation)	-25 °C ... 90 °C

Cable/line

Cable length	5 m
--------------	-----

PROFINET PVC stranded CAT5 [93B]

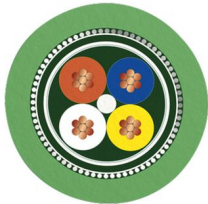
Dimensional drawing	
Cable weight	67 kg/km
UL AWM Style	21694
Number of positions	4
Shielded	yes
Cable type	PROFINET PVC stranded CAT5 [93B]
Conductor structure	1x4xAWG22/7, SF/TQ
Signal runtime	5.3 ns/m
Signal speed	0.66 c
Conductor structure signal line	7x 0.25 mm
AWG signal line	22
Conductor cross section	4x 0.34 mm ²
Wire diameter incl. insulation	1.55 mm
External cable diameter	6.5 mm ±0.2 mm
Outer sheath, material	PVC

NBC- 5,0-93B/M12FSD - Network cable



1407530

<https://www.phoenixcontact.com/us/products/1407530>

External sheath, color	green RAL 6018
Conductor material	Tin-plated Cu litz wires
Material wire insulation	PE
Single wire, color	white, yellow, blue, orange
Thickness, outer sheath	approx. 0.9 mm
Overall twist	Star quad
Optical shield covering	85 %
Insulation resistance	≥ 500 MΩ*km
Coupling resistance	≤ 20.00 mΩ/m (at 10 MHz)
Loop resistance	≤ 120.00 Ω/km
Wave impedance	100 Ω ±15 Ω (at 100 MHz)
Nominal voltage, cable	600 V
Test voltage Core/Core	2000 V (50 Hz, 1 min.)
Test voltage Core/Shield	2000 V (50 Hz, 1 min.)
Minimum bending radius, fixed installation	3 x D
Minimum bending radius, flexible installation	7 x D
Smallest bending radius, fixed installation	20 mm
Smallest bending radius, movable installation	46 mm
Near end crosstalk attenuation (NEXT)	80 dB (with 1 MHz)
	76 dB (at 4 MHz)
	70 dB (at 10 MHz)
	65 dB (at 16 MHz)
	63 dB (at 20 MHz)
	60 dB (at 31.25 MHz)
	55 dB (at 62.5 MHz)
	50 dB (at 100 MHz)
Shield attenuation	2.1 dB (with 1 MHz)
	4 dB (at 4 MHz)
	6.3 dB (at 10 MHz)
	8 dB (at 16 MHz)
	9 dB (at 20 MHz)
	11.4 dB (at 31.25 MHz)
	16.5 dB (at 62.5 MHz)
	21.3 dB (at 100 MHz)
Flame resistance	according to UL 1685 (CSA FT 4)
Resistance to oil	Resistant to oil to a limited extent
Other resistance	UV resistant (According to UL 1581, Section 1200)
Ambient temperature (operation)	-40 °C ... 70 °C (cable, fixed installation)
	-40 °C ... 70 °C (Cable, flexible installation)
Ambient temperature (installation)	-20 °C ... 60 °C

Environmental and real-life conditions

Ambient conditions

NBC- 5,0-93B/M12FSD - Network cable



1407530

<https://www.phoenixcontact.com/us/products/1407530>

Degree of protection	IP65
	IP67

Standards and regulations

M12

Standard designation	M12 connector
Standards/specifications	IEC 61076-2-101

Drawings

Circuit diagram

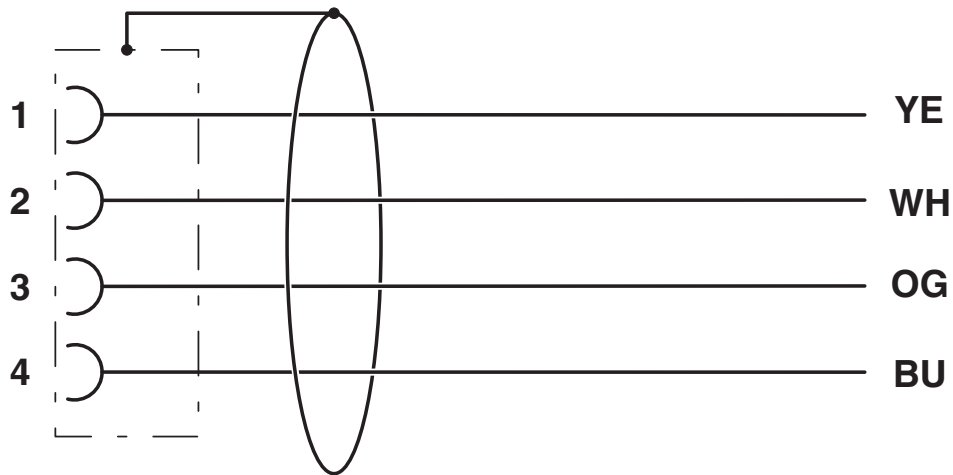

Dimensional drawing

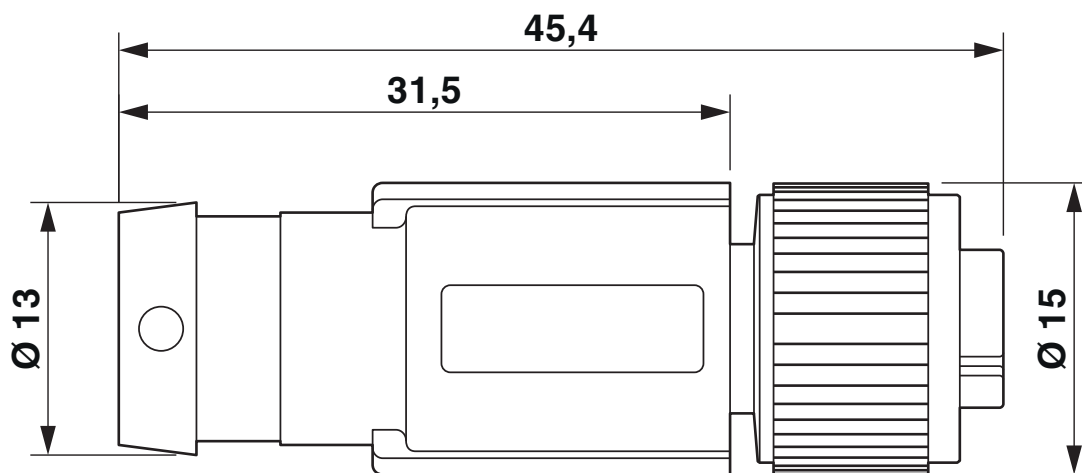

M12 x 1 socket, straight, shielded

1407530

<https://www.phoenixcontact.com/us/products/1407530>

Schematic diagram



Pin assignment M12 socket, 4-pos., D-coded, female side

NBC- 5,0-93B/M12FSD - Network cable





1407530

<https://www.phoenixcontact.com/us/products/1407530>

Approvals

To download certificates, visit the product detail page: <https://www.phoenixcontact.com/us/products/1407530>

 cUL Recognized Approval ID: FILE E 335024				
	Nominal voltage U_N	Nominal current I_N	Cross section AWG	Cross section mm^2
	250 V	4 A	-	-

 UL Recognized Approval ID: FILE E 335024				
	Nominal voltage U_N	Nominal current I_N	Cross section AWG	Cross section mm^2
	250 V	4 A	-	-

 EAC-RoHS Approval ID: RU D-DE.HB35.B.00387	
---	--

cULus Recognized	
-------------------------	--

NBC- 5,0-93B/M12FSD - Network cable



1407530

<https://www.phoenixcontact.com/us/products/1407530>

Classifications

ECLASS

ECLASS-11.0	27060307
ECLASS-12.0	27060307
ECLASS-13.0	27060307

ETIM

ETIM 9.0	EC001855
----------	----------

UNSPSC

UNSPSC 21.0	26121600
-------------	----------

NBC- 5,0-93B/M12FSD - Network cable



1407530

<https://www.phoenixcontact.com/us/products/1407530>

Environmental product compliance

China RoHS	Environmentally friendly use period: unlimited = EFUP-e
	No hazardous substances above threshold values

NBC- 5,0-93B/M12FSD - Network cable



1407530

<https://www.phoenixcontact.com/us/products/1407530>

Accessories

NBC-MSD SCO-PN/.../... - Network cable

1408640

<https://www.phoenixcontact.com/us/products/1408640>



Network cable, PROFINET CAT5 (100 Mbps), EtherCAT® CAT5 (100 Mbps), 4-position, Variable cable type, shielded, Plug straight M12 SPEEDCON, coding: D / IP67, on free cable end, cable length: Free input (0.2 ... 40.0 m)

NBC-MRD SCO-PN/.../... - Network cable

1408633

<https://www.phoenixcontact.com/us/products/1408633>



Network cable, PROFINET CAT5 (100 Mbps), EtherCAT® CAT5 (100 Mbps), 4-position, Variable cable type, shielded, Plug angled M12 SPEEDCON, coding: D / IP67, on free cable end, cable length: Free input (0.2 ... 40.0 m)

NBC- 5,0-93B/M12FSD - Network cable

1407530

<https://www.phoenixcontact.com/us/products/1407530>



NBC-FSD SCO-PN/.../... - Network cable

1408623

<https://www.phoenixcontact.com/us/products/1408623>

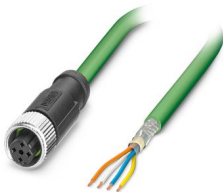

Network cable, PROFINET CAT5 (100 Mbps), EtherCAT[®] CAT5 (100 Mbps), 4-position, Variable cable type, shielded, free cable end, on Socket straight M12 SPEEDCON, coding: D / IP67, cable length: Free input (0.2 ... 40.0 m)

NBC-FRD SCO-PN/.../... - Network cable

1408615

<https://www.phoenixcontact.com/us/products/1408615>

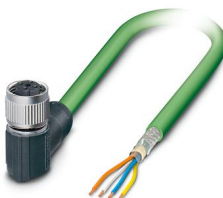

Network cable, PROFINET CAT5 (100 Mbps), EtherCAT[®] CAT5 (100 Mbps), 4-position, Variable cable type, shielded, free cable end, on Socket angled M12 SPEEDCON, coding: D / IP67, cable length: Free input (0.2 ... 40.0 m)

NBC- 5,0-93B/M12FSD - Network cable

1407530

<https://www.phoenixcontact.com/us/products/1407530>



PROT-M12 MS-PA-CHAIN - Screw plug

1430899

<https://www.phoenixcontact.com/us/products/1430899>

M12 sealing cap with fixing band, for sensor cables, for free M12 sockets



SAC-M12-EXCLIP-F - Locking clip

1558991

<https://www.phoenixcontact.com/us/products/1558991>

Locking clip for the socket side of sensor/actuator cables with M12 connector and M12 connectors for assembly, for knurl diameter: 15 mm or for Allen key with a wrench size of 14 mm, prevents the disconnection of plug-in connections without tools



NBC- 5,0-93B/M12FSD - Network cable

1407530

<https://www.phoenixcontact.com/us/products/1407530>



WP-CTA POM 13,0 BK - Protective hose adapter

1422884

<https://www.phoenixcontact.com/us/products/1422884>



Protective hose adapter, for corrugated hoses with a nominal size of 13 (10 x 13), corrugated in parallel

WP-PA HF 13,0 BK - Protective hose

3240681

<https://www.phoenixcontact.com/us/products/3240681>



Protective hose, material: PA 6, UV-resistant: yes, flexible, degree of protection: IP68, color: black, flammability rating in acc. with UL 94: V0, inner diameter: 10 mm, Total length: 50 m

NBC- 5,0-93B/M12FSD - Network cable

1407530

<https://www.phoenixcontact.com/us/products/1407530>



WP-PA HF-HB 13,0 BK - Protective hose

3240839

<https://www.phoenixcontact.com/us/products/3240839>



Protective hose, material: PA 6, UV-resistant: yes, flexible, degree of protection: IP68, color: black, flammability rating in acc. with UL 94: HB, inner diameter: 10 mm, Total length: 50 m

SACC-M12MSD-4QO SH PN - Data connector

1411068

<https://www.phoenixcontact.com/us/products/1411068>



Data connector, PROFINET CAT5 (100 Mbps), 4-position, halogen-free, shielded, Plug straight M12, coding: D, Insulation displacement connection, knurl material: Zinc die-cast, nickel-plated, external cable diameter 5 mm ... 9.7 mm

NBC- 5,0-93B/M12FSD - Network cable



1407530

<https://www.phoenixcontact.com/us/products/1407530>

SACC-M12MRD-4Q SH PN - Data connector

1554539

<https://www.phoenixcontact.com/us/products/1554539>



Data connector, PROFINET CAT5 (100 Mbps), 4-position, shielded, Plug angled M12, coding: D, Insulation displacement connection, knurl material: Brass, nickel-plated, external cable diameter 4 mm ... 8 mm

SACC-M12FSD-4QO SH PN - Data connector

1411071

<https://www.phoenixcontact.com/us/products/1411071>



Data connector, PROFINET CAT5 (100 Mbps), 4-position, halogen-free, shielded, Socket straight M12, coding: D, Insulation displacement connection, knurl material: Zinc die-cast, nickel-plated, external cable diameter 5 mm ... 9.7 mm

NBC- 5,0-93B/M12FSD - Network cable

1407530

<https://www.phoenixcontact.com/us/products/1407530>



SACC-M12FRD-4Q SH PN - Data connector

1554542

<https://www.phoenixcontact.com/us/products/1554542>



Data connector, PROFINET CAT5 (100 Mbps), 4-position, shielded, Socket angled M12, coding: D, Insulation displacement connection, knurl material: Brass, nickel-plated, external cable diameter 4 mm ... 8 mm

SACC-CC-4QO SH PN - Conductor connectors

1414416

<https://www.phoenixcontact.com/us/products/1414416>



Cable connector, PROFINET CAT5 (100 Mbps), 4-pos., halogen-free, shielded, insulation displacement connection, housing material: zinc die-cast, nickel-plated, outer cable diameter of 5 mm ... 9.7 mm

NBC- 5,0-93B/M12FSD - Network cable

1407530

<https://www.phoenixcontact.com/us/products/1407530>



SACC-M12MSD-4PL SH PN - Connector

1424682

<https://www.phoenixcontact.com/us/products/1424682>



Connector, PROFINET CAT5 (100 Mbps), 4-position, shielded, Plug straight M12, coding: D, Push-lock spring connection, knurl material: Zinc die-cast, nickel-plated, external cable diameter 4 mm ... 8 mm

SACC-M12MRD-4PL SH PN - Connector

1424684

<https://www.phoenixcontact.com/us/products/1424684>



Connector, PROFINET CAT5 (100 Mbps), 4-position, shielded, Plug angled M12, coding: D, Push-lock spring connection, knurl material: Zinc die-cast, nickel-plated, external cable diameter 4 mm ... 8 mm

NBC- 5,0-93B/M12FSD - Network cable

1407530

<https://www.phoenixcontact.com/us/products/1407530>

SACC-M12FSD-4PL SH PN - Connector

1424683

<https://www.phoenixcontact.com/us/products/1424683>



Connector, PROFINET CAT5 (100 Mbps), 4-position, shielded, Socket straight M12, coding: D, Push-lock spring connection, knurl material: Zinc die-cast, nickel-plated, external cable diameter 4 mm ... 8 mm

SACC-M12FRD-4PL SH PN - Connector

1424685

<https://www.phoenixcontact.com/us/products/1424685>



Connector, PROFINET CAT5 (100 Mbps), 4-position, shielded, Socket angled M12, coding: D, Push-lock spring connection, knurl material: Zinc die-cast, nickel-plated, external cable diameter 4 mm ... 8 mm

NBC- 5,0-93B/M12FSD - Network cable

1407530

<https://www.phoenixcontact.com/us/products/1407530>



SACC-M12MSD-4CT-CM SH PN - Data connector

1422846

<https://www.phoenixcontact.com/us/products/1422846>



Data connector, PROFINET CAT5 (100 Mbps), 4-position, shielded, Plug straight M12, coding: D, Crimp connection, knurl material: Zinc die-cast, tin-plated, external cable diameter 4.5 mm ... 7.5 mm, without crimp contacts

SACC-M12MRD-4CT-CM SH PN - Data connector

1422847

<https://www.phoenixcontact.com/us/products/1422847>



Data connector, PROFINET CAT5 (100 Mbps), 4-position, shielded, Plug angled M12, coding: D, Crimp connection, knurl material: Zinc die-cast, tin-plated, external cable diameter 4.5 mm ... 7.5 mm, without crimp contacts

NBC- 5,0-93B/M12FSD - Network cable

1407530

<https://www.phoenixcontact.com/us/products/1407530>

SACC-M12FSD-4CT-CM SH PN - Data connector

1422848

<https://www.phoenixcontact.com/us/products/1422848>



Data connector, PROFINET CAT5 (100 Mbps), 4-position, shielded, Socket straight M12, coding: D, Crimp connection, knurl material: Zinc die-cast, tin-plated, external cable diameter 4.5 mm ... 7.5 mm, without crimp contacts

SACC-M12FRD-4CT-CM SH PN - Data connector

1422849

<https://www.phoenixcontact.com/us/products/1422849>



Data connector, PROFINET CAT5 (100 Mbps), 4-position, shielded, Socket angled M12, coding: D, Crimp connection, knurl material: Zinc die-cast, tin-plated, external cable diameter 4.5 mm ... 7.5 mm, without crimp contacts

NBC- 5,0-93B/M12FSD - Network cable

1407530

<https://www.phoenixcontact.com/us/products/1407530>



VS-PN-RJ45-5-Q/IP20 - RJ45 connector

1658435

<https://www.phoenixcontact.com/us/products/1658435>



RJ45 connector, design: RJ45, degree of protection: IP20, number of positions: 4, 100 Mbps, CAT5, material: Plastic, connection method: Insulation displacement connection, cable outlet: straight, color: traffic grey A RAL 7042, PROFINET

CUC-IND-C1ZNI-S/R4IP8 - RJ45 connector

1421126

<https://www.phoenixcontact.com/us/products/1421126>



RJ45 connector, design: RJ45, degree of protection: IP20, number of positions: 8, 1 Gbps, CAT5, material: Metal, connection method: Insulation displacement connection, connection cross section: AWG 23- 22, cable outlet: straight, color: green, Ethernet/PROFINET

NBC- 5,0-93B/M12FSD - Network cable



1407530

<https://www.phoenixcontact.com/us/products/1407530>

CUC-IND-C1ZNI-T/R4IP8 - RJ45 connector

1421128

<https://www.phoenixcontact.com/us/products/1421128>



RJ45 connector, design: RJ45, degree of protection: IP20, number of positions: 8, 1 Gbps, CAT5, material: Metal, connection method: Insulation displacement connection, connection cross section: AWG 23- 22, cable outlet: angled, Ethernet/PROFINET

CUC-IND-C1ZNI-B/R4IP8 - RJ45 connector

1421127

<https://www.phoenixcontact.com/us/products/1421127>



RJ45 connector, design: RJ45, degree of protection: IP20, number of positions: 8, 1 Gbps, CAT5, material: Metal, connection method: Insulation displacement connection, connection cross section: AWG 23- 22, cable outlet: angled, Ethernet/PROFINET

NBC- 5,0-93B/M12FSD - Network cable

1407530

<https://www.phoenixcontact.com/us/products/1407530>

CUC-V14-C1ZNI-S/R4P8 - RJ45 connector

1422664

<https://www.phoenixcontact.com/us/products/1422664>



RJ45 connector, degree of protection: IP65/IP67, number of positions: 8, 1 Gbps, CAT5, material: Metal, connection method: IDC fast connection, connection cross section: AWG 23- 22, cable outlet: straight, Ethernet

CUC-V14-C1ZNI-T/R4P8 - RJ45 connector

1422667

<https://www.phoenixcontact.com/us/products/1422667>



RJ45 connector, degree of protection: IP65/IP67, number of positions: 8, 1 Gbps, CAT5, material: Metal, connection method: IDC fast connection, connection cross section: AWG 23- 22, cable outlet: angled, Ethernet

NBC- 5,0-93B/M12FSD - Network cable

1407530

<https://www.phoenixcontact.com/us/products/1407530>



CUC-V14-C1ZNI-B/R4P8 - RJ45 connector

1422665

<https://www.phoenixcontact.com/us/products/1422665>



RJ45 connector, degree of protection: IP65/IP67, number of positions: 8, 1 Gbps, CAT5, material: Metal, connection method: IDC fast connection, connection cross section: AWG 23- 22, cable outlet: angled, Ethernet

TSD 04 SAC - Torque screwdriver

1208429

<https://www.phoenixcontact.com/us/products/1208429>



Torque screwdriver, with preset torque of 0.4 Nm and 4 mm hexagonal drive for M12 connectors

NBC- 5,0-93B/M12FSD - Network cable

1407530

<https://www.phoenixcontact.com/us/products/1407530>



TSD-M 1,2NM - Torque screwdriver

1212224

<https://www.phoenixcontact.com/us/products/1212224>



Torque screw driver, accuracy as per EN ISO 6789 standard, adjustable from 0.3 - 1.2 Nm

TSD-M SAC-BIT ADAPTER - Adapter insert

1212600

<https://www.phoenixcontact.com/us/products/1212600>



Adapter bit for TSD-M...torque tools, E6.3-1/4" drive with 4 mm hexagon to accommodate SAC bits

NBC- 5,0-93B/M12FSD - Network cable

1407530

<https://www.phoenixcontact.com/us/products/1407530>



SAC BIT M12-D15 - Tool

1208432

<https://www.phoenixcontact.com/us/products/1208432>



Nut for assembling sensor/actuator cables with M12 connector and M12 connectors for assembly, with a knurl diameter of 15 mm, for 4 mm hexagonal drive

CUTFOX 12 - Cable-cutting tool

1212128

<https://www.phoenixcontact.com/us/products/1212128>



Cable cutter, for copper and aluminum up to 12 mm diameter (up to 35 mm²)

NBC- 5,0-93B/M12FSD - Network cable

1407530

<https://www.phoenixcontact.com/us/products/1407530>



CUTFOX-S VDE - Diagonal cutter

1212207

<https://www.phoenixcontact.com/us/products/1212207>



Diagonal cutter for hard (piano wire) and soft wires, VDE 1000 V AC/1500 V DC tested

VS-CABLE-STRIP-VARIO - Stripping tool

1657407

<https://www.phoenixcontact.com/us/products/1657407>

Stripping tool, for the multi-level stripping of shielded cables



NBC- 5,0-93B/M12FSD - Network cable

1407530

<https://www.phoenixcontact.com/us/products/1407530>



MICROFOX-SP-1 - Diagonal cutter

1212487

<https://www.phoenixcontact.com/us/products/1212487>



Electronic diagonal cutter, tapered head, without chamfer, with opening spring, non-reflective phosphate-treated surface, punched version

WIREFOX 4 - Stripping tool

1212156

<https://www.phoenixcontact.com/us/products/1212156>



Stripping tool, for cables and conductors (especially for rubber and silicone insulations) from 0.1 - 4 mm², self-adjusting, stripping length of up to 18 mm, cutting capacity of up to 10 mm² stranded/1.5 mm² solid, replaceable stripping blade

NBC- 5,0-93B/M12FSD - Network cable



1407530

<https://www.phoenixcontact.com/us/products/1407530>

WIREFOX-E 4 - Stripping tool

1212704

<https://www.phoenixcontact.com/us/products/1212704>



Stripping tool, for cables and conductors (especially for rubber and silicone insulations) from 0.1 - 4 mm², self-adjusting, stripping length of up to 18 mm, cutting capacity of up to 10 mm² stranded/1.5 mm² solid, replaceable stripping blade

WIREFOX 10 - Stripping tool

1212150

<https://www.phoenixcontact.com/us/products/1212150>



Stripping tool, for cables and conductors from 0.02 - 10 mm², self-adjusting, stripping length of up to 18 mm, cutting capacity of up to 10 mm² stranded/1.5 mm² solid, replaceable stripping blade

Phoenix Contact 2024 © - all rights reserved
<https://www.phoenixcontact.com>

Phoenix Contact USA
586 Fulling Mill Road
Middletown, PA 17057, United States
(+717) 944-1300
info@phoenixcon.com